



Simulation and Optimization of LNG Production Unit for Energy Conservations

Ali Tarjoman Nejad and Ali Farzi

Department of Chemical Engineering, University of Tabriz, P.O. Box: 5166616471, Tabriz, Iran

(Received: January 6, 2014; Accepted in Revised Form: March 14, 2014)

Abstract: The prospect of LNG could become a major global energy source is one of the most debated issues. The Liquefied Natural Gas (LNG) supply chain and the properties that make this fuel environmental friendly is in high demand for energy supply. In this paper, at first, the process of converting the natural gas to LNG was simulated; then, the process is optimized to archive minimum energy consumption per ton of LNG produced. Using a three stage exchanger is the best way for minimization of energy consumption in LNG production unit. Outlet pressure from the compressor and also type of refrigerant in cooling system is very effective on rate of energy conservations. The best mass fraction for refrigerants in liquefaction cycle are 0.88 for methane and 0.12 for ethane. For subcooling cycle that fraction is defined as 0.6 for methane and 0.4 for nitrogen. The optimized pressure in outlet of compressors in liquefaction cycle is 650 kPa; also, for the subcooling cycle is 1800 kPa. The amount of consumed energy was 14.91 kW per ton of produced LNG.

Key words: Natural gas • LNG • Energy optimization • Simulation • Refrigeration cycle

INTRODUCTION

For production of LNG the natural gas is cooled down to temperature of -161°C . In this case, the gas turned to an odorless and transparent liquid with density about 450 kg/m^3 . The gas volume is reduced to 1/600 with liquefaction which economizes transportation of natural gas [1].

LNG is an environmental friendly fuel and this factor together with economic factors causes this fuel to be very important and be pursued [1]. LNG market in Asia, Northern America and Europe progressively developed in past decades [2]. For production of LNG, the natural gas temperature should decrease to -161°C while the pressure has to increase to 5 bar.

Various refrigerants can be used for LNG process. The best and the most available ones are: R-22, methane, ethane and nitrogen [3]. In this work, these refrigerants have been used for the liquefaction of natural gas.

Process Description: LNG exchanger should be used for cooling natural gas temperature to -161°C . Three stage exchangers can be used for this purpose. In first stage which is precooling stage, natural gas is cooled down to -40°C . In the second stage which is liquefaction stage, natural gas is cooled to -90°C . Finally, in the third stage which is subcooling stage, natural gas is cooled down to -161°C [4].

The plate-fin heat exchanger are often used to achieve such temperature. A brazed aluminium plate-fin heat exchanger consists of a block of alternating layers of corrugated fins. The layers are separated from each other by parting sheets and sealed along the edges by means of side bars and are provided with inlet and outlet ports for the streams. The block is bounded by cap sheets at top and bottom. The minimum design temperature for this heat exchanger is -269°C [4].

In general, fluids should be clean, dry and noncorrosive to aluminium. Trace impurities of H_2S , NH_3 , CO_2 , SO_2 , NO_2 , CO , Cl_2 and other acid-forming gases do

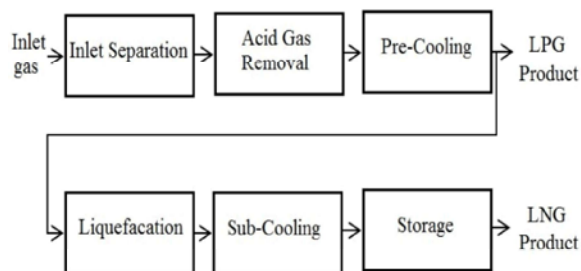

Fig. 1: The actual process flow diagram

not create corrosion problem in streams with water dew point temperatures lower than the cold-end temperature of the brazed aluminium plate-fin heat exchanger [5]. Acid gas removal is performed first to reduce carbon dioxide levels to around 50 ppm. To remove CO₂ from natural gas, amine tower can be used [6]. The process flow diagram of LNG production is shown in Fig. 1.

Precooling: In precooling stage, R-22 has been used as a refrigerant and J-T valves are also used. The J-T valve can be designed for any pressure drop. Joule-Thomson effect is made by using j-t valve. When Joule-Thomson coefficient is positive, a drop in pressure means a drop in temperature. In this situation Joule-Thomson coefficient for R-22 will be positive. So, Temperature in the cycle will decrease.

Inlet natural gas feed is in temperature of 25 °C and the pressure of 7 bar. In initial stage, the temperature is reduced to -40 °C. The temperature cannot be reduced to lower than the stated temperature using R-22. In this stage, a flash drum is used for the separation of LPG gas. In flash drum, water is separated in addition to LPG. In order to prevent freezing of water in the subsequent stages, separation of water is very important in the cryogenic process. It is crucial for water vapor content compressed gas should be reduced to lower than 1ppmv [7].

Liquefaction: In this stage, one LNG exchanger with three streams is used. Although one refrigerant can be used for cooling, but use of mixture of two refrigerants is more desired, because it guarantees more ranges for existence of two phases [8]. The first stream is a mixture of methane and ethane. This stream is a part of stage which includes a compressor, a chiller and a turbine. The second stream is a mixture of nitrogen and methane. It is cooled in the LNG exchanger for using in third exchanger i.e. subcooling stage.

In second stage, the first stream enters to the compressor for increasing its pressure, then it enters into a chiller for the reduction of its temperature. At last, it enters into a turbine and then enters LNG exchanger.

Subcooling: In the third stage, the stream enters a compressor for increasing its pressure, then it enters the first LNG exchanger of its precooling. Then, it enters a turbine and its pressure is reduced and finally it enters the second LNG exchanger. In this stage, the temperature of refrigerants stream should be -165 °C in order to reduce the temperature of natural gas to -161 °C.

Boil-off Gas (BOG) is the vapor phase in LNG tanks. The increase in BOG will lead to an increase in pressure of LNG tank, as the specific volume of gas is much larger than that of liquid form. It seems that BOG can be a serious problem for LNG storage tanks [9].

At the end of the process, LNG enters the storage tanks where 5% of LNG is evaporated. Boil-off gas is compressed to the pressure of natural gas and is recycled and added to the feed.

Simulation: ASPEN HYSYS software was used for the simulation of LNG production unit. Because, in this simulation available components are hydrocarbon and nonpolar, Peng Robinson equation of state is used for thermodynamic calculations [10]. The simulation environment for the process is shown in Fig. 2. The properties of produced LNG are summarized in Table 1.

Optimization: The effective parameters on energy consumption should be recognized for the optimization of consumed energy. The kind of refrigerant important in consumed energy. For the stages it is more desired to use the refrigerants in such a way that temperature ranges of the stages have optimal performance. It is suitable to use more than one refrigerant in the stage to increase the range of existence two phases. Two refrigerants of methane and ethane are appropriate for liquefaction stage while two refrigerants of methane and nitrogen are appropriate for subcooling stage. This choice is due to high efficiency of these refrigerants within the temperature ranges of stages. The best mass fraction of refrigerants should be specified for both cycles. The consumed energy per ton of LNG versus the mass fraction of the refrigerants for liquefaction and subcooling cycles are shown in Figs. 3 and 4.

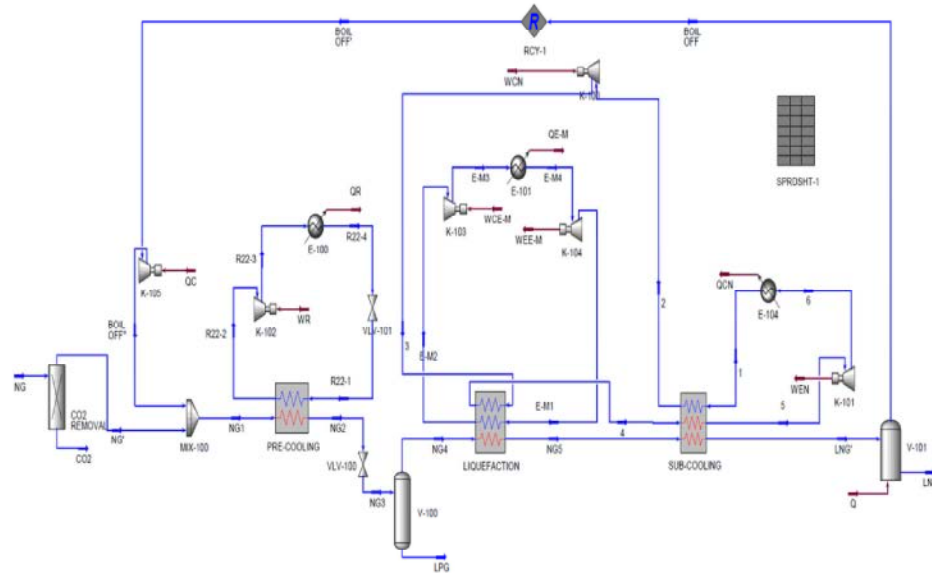

Fig. 2: LNG unit simulation environment

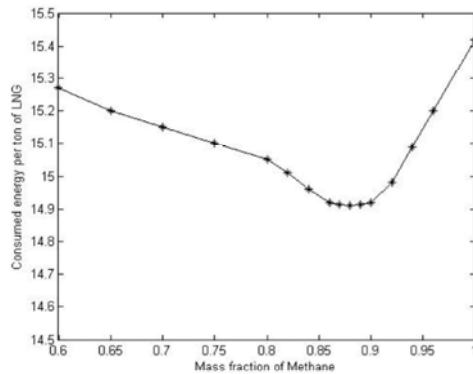

Fig. 3: Consumed energy per ton of produced LNG vs the mass fraction of Methane in liquefaction cycle

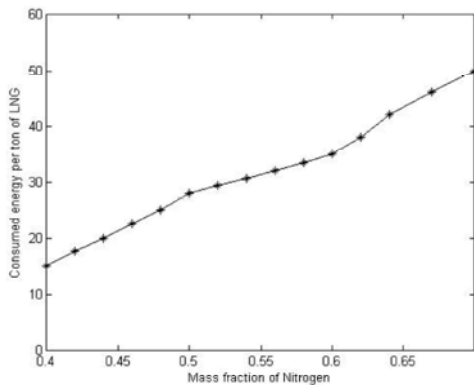

Fig. 4: Consumed energy per ton of produced LNG vs the mass fraction of Nitrogen in sub-cooling cycle

Table 1: The properties of produced LNG obtained by simulation

Parameters	Value
vapor phase fraction	0
Temperature (°C)	-160
Pressure (kPa)	500
mass density (kg/m ³)	458.357
mass heat capacity (kJ/kg.C)	3.192
Viscosity (cP)	0.113
Thermal conductivity (W/m.k)	0.186
Mass heat of vaporization (kCal/kg)	156.047

The results showed that the best mass fraction of refrigerants in liquefaction stage defined as 0.88 for methane and 0.12 for ethane. In subcooling stage, consumed energy decreases with decreasing of nitrogen mole fraction, but LNG exchanger can't act properly for mass fractions lower than 0.4 and temperature cross is occurred in the exchanger. Therefore, the mass fraction of nitrogen was considered to be 0.4. In Table 2 shows the mass fraction of refrigerants for liquefaction and subcooling stages.

The outlet pressure of compressor has very important effect on energy consumption. When the pressure increases, the turbine outlet temperature can be reduced, but this leads to an increase in energy consumption of compressor [11]. When the pressure is reduced, more energy in chiller is required. Therefore, the optimized pressure should be considered for the stages. In Fig. 5 depicts the consumed energy per ton of

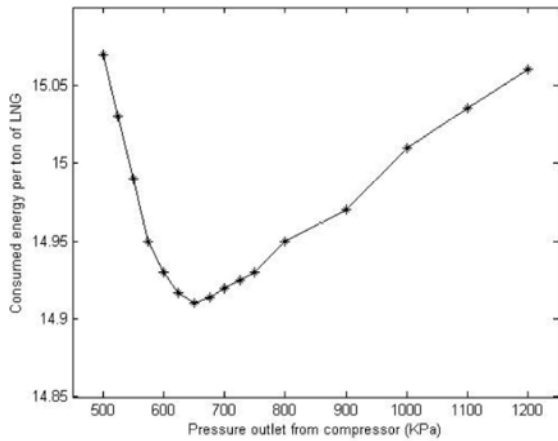

Fig. 5: Consumed energy vs the outlet pressure from compressor for liquefaction cycle

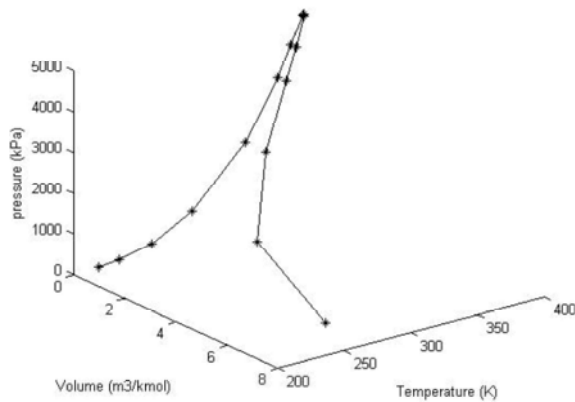

Fig. 6: PVT diagram for precooling cycle

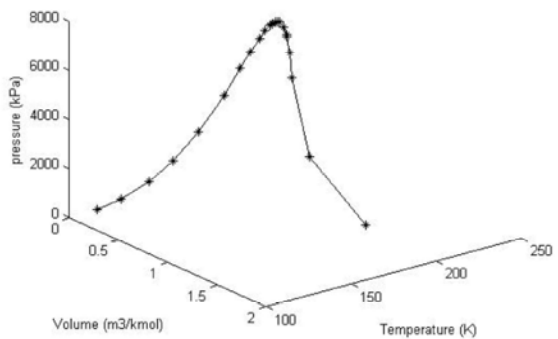

Fig. 7: PVT diagram for liquefaction cycle

produced LNG versus the outlet pressure of the compressor for liquefaction stage. The optimized pressure for this compressor is 650 kPa.

In subcooling stage, the compressor outlet pressure should be high, because of the refrigerants are needed in very low temperature. In this situation, the least possible

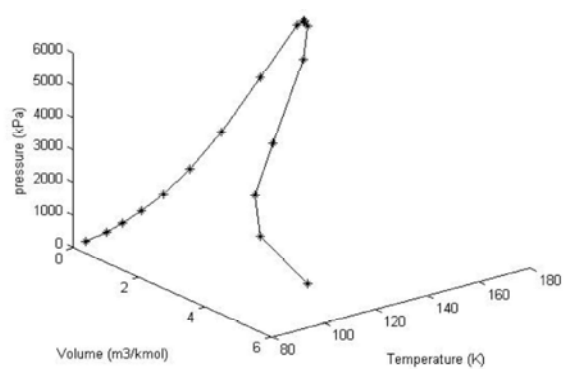

Fig. 8: PVT diagram for subcooling cycle

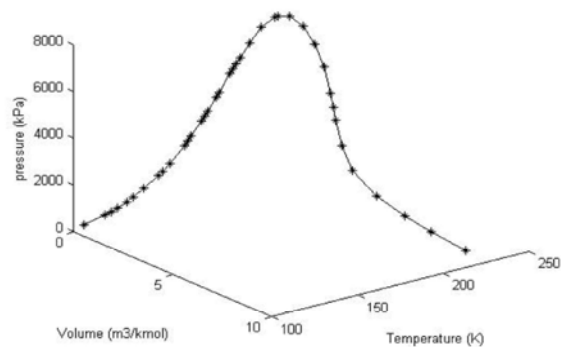

Fig. 9: PVT diagram for final LNG product

Table 2: Optimal refrigerants mass fraction obtained by ASPEN HYSYS

Stage	Refrigerant	Mass fraction
liquefaction	Ethane	0.12
	Methane	0.88
Subcooling	Nitrogen	0.4
	Methane	0.6

Table 3: Specifications of streams in liquefaction stage

Variables	E-M1	E-M2	E-M3	E-M4
Vapor fraction	0.963	1	1	1
Temperature (°C)	-115.1	-112.7	-78.2	-103.3
Pressure (kPa)	400	390	700	700

Table 4: Specifications of streams in subcooling stage

Variables	1	2	3	4	5	6
Vapor fraction	0.345	0.999	1	1	1	1
Temperature (°C)	-165	-150.4	-71.8	-60	-74	-126.8
Pressure (kPa)	400	390	1800	1790	1780	420

pressure for prevention of temperature crosses in LNG exchanger and reach to the desired temperature is 1800 kPa. If the pressure increases to high value, then the consumed energy will also increase. The temperature and pressure of each of the streams in liquefaction and subcooling stages are summarized in Tables 3 and 4. At optimal conditions, amount of consumed energy per ton of LNG is 14.91 kW.

Table 5: Comparison between various designs

Design	Process	Compression Eff. %	kW/ton
Conoco Phillips	Optimized Cascade Refrigeration	100	14.1
Prico	Single Mixed Refrigeration	100	16.8
Dual TEX Cycle	Turbo-Expander	100	16.5
Kryopak EXP	Turbo-Expander	100	15.5
This work	Three stage exchanger - Mixed Refrigeration	75	14.91

In Figs. 6 to 8, PVT diagram for precooling, liquefaction and subcooling cycles are shown. According to the presented data, with the increasing number of materials in stream, two-phase region is broader. Operating Temperature cycles from the first to the third cycle is reduced. In Fig. 9, PVT diagram for final LNG product is shown. The final product is in liquid zone.

In this paper simulated design is compared with some conventional processes. This comparison is shown in Table 5. Only ConocoPhillips method has less energy consumption, but the energy consumption for this process is calculated in 100% compression efficient while in this design the efficiency is intended to 75%. So the design has lower energy consumption in real situation.

CONCLUSIONS

Using a three stage exchanger is the best arrangements for the optimization of energy consumption in LNG production unit. The outlet pressure from the compressor and the kind of refrigerants are very effective on energy consumption. Energy consumption can be reduced by obtaining the optimized pressure for the compressor and by obtaining the best mass fraction for the refrigerants. The best mass fraction of refrigerants in the liquefaction stage is 0.88 for methane and 0.12 for ethane and for subcooling stage is 0.6 for methane and 0.4 for nitrogen. The optimal outlet pressure from the compressor in liquefaction and subcooling stages were 650 and 1800 kPa, respectively. In this optimal condition, consumed energy per ton of LNG is 14.91 kW.

REFERENCES

1. Aoki, I. and Y. Kikkawa, 1995. Technical efforts focus on cutting LNG plant costs. *Oil and Gas Journal*, 93(27).
2. Kikkawa, Y., M. Nakamura and S. Sugiyama, 1997. Development of liquefaction process for natural gas. *Journal of Chemical Engineering of Japan*, 30(4): 625-630.
3. Geist, J., 1985. Refrigeration cycles for future base-load LNG plants need a close look. *Oil and Gas Journal*, 83(5).
4. Habibullah, A., P. Lardi and M. Passmore, 2009. LNG conceptual design strategies. in *The 88th GPA Annual Convention in San Antonio, TX. 2009*.
5. ALPEMA, 2000. The standard of the brazed aluminium plate-fin heat exchanger manufacturers association. Second Edition.
6. Lorn, W. *Liquefied Natural Gas*, 1974, Applied Science Publishers Ltd, Barking.
7. Jamieson, D., P. Johnson and P. Redding, Targeting and achieving lower cost liquefaction plants. in *Twelfth International Conference and Exhibition on Liquefied Natural Gas*, Perth, Australia. 1998.
8. Haywood, R., 1990. *Analysis of Engineering Cycles*, 1990, Pergamon Press, Oxford.
9. Aimikhe, V., B. Kinigoma and E. Iyagba, 2013. Predicting the Produced Boil off Gas in the Moss Spherical Liquefied Natural Gas (LNG) Vessel. in *SPE Nigeria Annual International Conference and Exhibition*. 2013. Society of Petroleum Engineers.
10. Carlson, E.C., 1996. Don't gamble with physical properties for simulations. *Chemical Engineering Progress*, 92(10): 35-46.
11. Alabdulkarem, A., A. Mortazavi, Y. Hwang, R. Radermacher and P. Rogers, 2011. Optimization of propane pre-cooled mixed refrigerant LNG plant. *Applied Thermal Engineering*, 31(6): 1091-1098.

Persian Abstract

DOI: 10.5829/idosi.ijee.2014.05.01.10

چکیده

این چشم انداز که LNG می‌تواند به یکی از مهمترین منابع انرژی در جهان تبدیل شود، همواره مورد بحث بوده است. LNG سوختی سازگار با محیط زیست است، این عامل علاوه بر عوامل اقتصادی موجب می‌شود که این فرایند بسیار مورد اهمیت باشد. در این مقاله ابتدا فرایند تبدیل گاز طبیعی به LNG شبیه سازی شده و سپس فرایند برای به دست آوردن حداقل مقدار انرژی مصرف شده به ازای هرتن LNG تولیدی بهینه شده است. برای بهینه کردن مصرف انرژی در واحد بهترین روش استفاده از یک فرایند سه مرحله‌ای است. فشار خروجی کمپرسور و نوع مبرد بر میزان انرژی مصرفی بسیار موثر هستند. بهترین کسر جرمی برای مبردها در سیکل مایع سازی برابر ۰/۸۸ برای متان و ۰/۱۲ برای اتان است. در سیکل سردسازی برابر ۰/۶ برای متان و ۰/۴ برای نیتروژن است. فشار بهینه در خروجی کمپرسور در سیکل مایع سازی برابر ۶۵۰ کیلوپاسکال و برای سیکل سردسازی برابر ۱۸۰۰ کیلوپاسکال به دست آمده است. میزان انرژی مصرفی به ازای هرتن از LNG تولیدی برابر ۱۴/۹۱ کیلو وات آمده است.
